

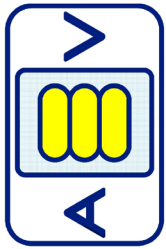

...your partner for vibration control!



Catalogo AV

GB

I

**AV****ANTIVIBRATION MOUNTS****ELSITEC** s.r.l.**INDEX / INDICE**

CYLINDRICAL BOBBINS 2M1 <i>ANTIVIBRANTE CILINDRICO 2M1</i>		Pag. AV-2
CYLINDRICAL BOBBINS MF <i>ANTIVIBRANTE CILINDRICO MF</i>		Pag. AV-3
CYLINDRICAL BOBBINS FF <i>ANTIVIBRANTE CILINDRICO FF</i>		Pag. AV-4
CYLINDRICAL BOBBINS PM <i>ANTIVIBRANTE CILINDRICO PM</i>		Pag. AV-5
CYLINDRICAL BOBBINS PF <i>ANTIVIBRANTE CILINDRICO PF</i>		Pag. AV-6
WAISTED BOBBINS AT <i>ANTIVIBRANTE SGOLATO AT</i>		Pag. AV-7
WAISTED BOBBINS BT <i>ANTIVIBRANTE SGOLATO BT</i>		Pag. AV-7
WAISTED BOBBINS CT <i>ANTIVIBRANTE SGOLATO CT</i>		Pag. AV-8
CONICAL BOBBINS CN <i>ANTIVIBRANTE CONICO CN</i>		Pag. AV-8
STAINLESS STEEL BOBBINS <i>ANTIVIBRANTI IN ACCIAIO INOX</i>		Pag. AV-9_15

© Copyright Elsitec srl. - Italy 2020

No part of this è publication may be reproduced by any means without the written permission of Elsitec S.r.l.
 Questa pubblicazione non può essere riprodotta anche in parte senza la preventiva autorizzazione scritta di Elsitec S.r.l.

**ELSITEC** s.r.l.

Via Apollo XI, 9 – 37057 San Giovanni Lupatoto – Verona – Italy – Tel 0039 (0)45 8751556 – Fax 0039 (0)45 8777218
 www.elsitec.it – e-mail: info@elsitec.it

Cylindrical Bobbins - Type: **2M1 Hardness 55 SHORE** / *Antivibrante Cilindrico - Tipo: 2M1 Durezza 55 SHORE*

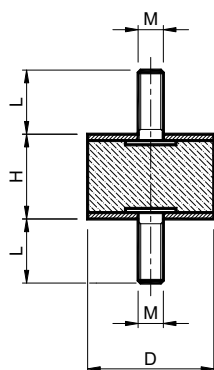

Antivibration mounts made by rubber and steel parts

MATERIALS metal components are zincplated

NR/SBR rubber compound

HARDNESS 55 SHORE +/-5%

USE male-male

Antivibranti gomma-metallo

MATERIALI parti metalliche sono zincate

Parti in gommamescola NR/SBR

DUREZZA 55 SHORE +/-5%

IMPIEGO maschio-maschio

Type Tipo	Cod. N°	D	H	L	M
2M1 06-07	AV001010	6	7	6	M3
M1 08-08	AV001013	8	8	6	M3
M1 10-08	AV001016	10	8	10	M4
2M1 10-10	AV001017	10	10	10	M4
2M 10-10-12	AV001018	10	10	12	M4
2M1 10-15	AV001019	10	15	10	M4
2M 10-15-12	AV001020	10	15	12	M4
2M 13-10	AV001023	13	10	10	M5
M1 15-6	AV001024	15	13	13	M4
M1 15-7	AV001027	15	6	10	M4
M1 15-8	AV001028	15	7	10	M4
2M1 15-10	AV001029	15	10	10	M4
M1 13-13	AV001030	15	13	13	M4
2M1 15-15	AV001031	15	15	14	M4
2M 15-15-19	AV001032	15	15	19	M4
M1 15-15-M5	AV001033	15	15	8	M5
2M1 15-20	AV001034	15	20	10	M4
2M1 15-30	AV001035	15	30	12	M4
2M 16-10	AV001040	16	10	12	M5
2M 16-20	AV001041	16	20	12	M5
2M1 20-8	AV001044	20	8	16	M6
2M1 20-10	AV001045	20	10	16	M6
2M 20-15	AV001046	20	15	16	M6
2M1 20-15-18	AV001047	20	15	18	M6
2M 20-20	AV001048	20	20	16	M6
2M1 20-20-18	AV001049	20	20	18	M6
2M1 20-25	AV001050	20	25	16	M6
2M 20-30	AV001051	20	30	16	M6
2M1 20-30-18	AV001052	20	30	18	M6
2M1 25-10	AV001057	25	10	20	M6
2M1 25-15	AV001058	25	15	18	M6
M1 25-18	AV001059	25	18	18	M6
2M1 25-20	AV001060	25	20	18	M6
2M1 25-25	AV001061	25	25	18	M6

Type Tipo	Cod. N°	D	H	L	M
2M1 25-30-6	AV001062	25	30	18	M6
2M 25-20-M8	AV001063	25	20	20	M8
2M 25-30-M8	AV001064	25	30	20	M8
2M1 30-10	AV001069	30	10	18	M6
2M1 30-15	AV001070	30	15	23	M8
2M 30-20-15	AV001071	30	20	15	M8
2M1 30-20-23	AV001072	30	20	23	M8
2M1 30-25	AV001073	30	25	20	M8
2M 30-30-18	AV001074	30	30	18	M6
2M1 30-30-23	AV001075	30	30	23	M8
2M1 30-40	AV001076	30	40	23	M8
M1 40-15	AV001080	40	15	20	M8
2M1 40-20	AV001081	40	20	23	M8
M1 40-20-M10	AV001082	40	20	28	M10
2M1 40-25	AV001083	40	25	23	M8
M1 40-25-M10	AV001084	40	25	28	M10
2M1 40-30	AV001085	40	30	23	M8
M1 40-35-M10	AV001086	40	30	28	M10
2M1 40-35	AV001087	40	35	23	M8
2M1 40-40	AV001088	40	40	23	M8
2M 40-45	AV001089	40	45	23	M8
2M 40-50	AV001090	40	50	23	M8
2M 40-30-M10	AV001091	40	30	28	M10
2M 40-40-M10	AV001092	40	40	28	M10
2M 50-40-M8	AV001100	50	40	25	M8
2M1 50-20	AV001101	50	20	28	M10
2M1 50-25	AV001102	50	25	28	M10
2M1 50-30	AV001103	50	30	28	M10
M1 50-35	AV001104	50	35	28	M10
2M1 50-40	AV001105	50	40	28	M10
2M1 50-45	AV001106	50	45	28	M10
2M1 50-50	AV001107	50	50	28	M10
2M 50-60	AV001108	50	60	28	M10
2M 60-25	AV001114	60	25	28	M10

Type Tipo	Cod. N°	D	H	L	M
2M1 60-30	AV001115	60	30	28	M10
2M 60-35	AV001116	60	35	28	M10
M1 60-40	AV001117	60	40	28	M10
2M 60-50	AV001118	60	50	35	M10
2M 60-60	AV001119	60	60	28	M10
2M1 60-30-M12	AV001120	60	30	37	M12
2M1 60-40-M12	AV001121	60	40	37	M12
2M 60-50-M12	AV001122	60	50	37	M12
2M 65-35	AV001128	65	35	37	M12
2M 65-50	AV001129	65	50	37	M12
2M 70-40	AV001132	70	40	28	M10
M1 70-45	AV001133	70	45	28	M10
2M 70-50	AV001134	70	50	28	M10
2M 70-50-M12	AV001135	70	50	37	M12
2M 75-50	AV001139	75	50	28	M10
2M1 75-25	AV001140	75	25	37	M12
2M1 75-40	AV001141	75	40	37	M12
2M1 75-50-M12	AV001142	75	50	37	M12
M1 75-55	AV001143	75	55	37	M12
M1 80-20	AV001147	80	20	33	M10
2M 80-40	AV001148	80	40	37	M12
2M 100-30	AV001152	100	30	42	M16
2M1 100-40	AV001153	100	40	42	M16
2M1 100-50	AV001154	100	50	42	M16
2M1 100-55	AV001155	100	55	42	M16
2M1 100-60	AV001156	100	60	42	M16
M1 100-75	AV001157	100	75	41	M16
M1 120-55	AV001161	120	55	48	M16
M1 150-50	AV001165	150	50	41	M16
M1 150-55	AV001166	150	55	41	M16
M1 150-75	AV001167	150	75	41	M16

Cylindrical Bobbins - Type : **MMT Hardness 45 SHORE** / *Antivibrante Cilindrico - Tipo: MMT Durezza 45 SHORE*

Type Tipo	Cod. N°	D	H	L	M	SHORE
2M 25-20 SH45	AV001176	25	20	18	M6	45
2M 30-15 SH45	AV001178	30	15	23	M8	45
2M 30-20 SH45	AV001180	30	20	23	M8	45
2M 30-30 SH45	AV001182	30	30	23	M8	45

Type Tipo	Cod. N°	D	H	L	M	SHORE
2M 40-30 SH45	AV001184	40	30	23	M8	45
2M 40-40 SH45	AV001186	40	40	23	M8	45
2M 50-30 SH45	AV001188	50	30	28	M10	45
2M 50-40 SH45	AV001190	50	40	28	M10	45

Cylindrical Bobbins - Type: **MF Hardness 55 SHORE** / *Antivibrante Cilindrico - Tipo: MF Durezza 55 SHORE*

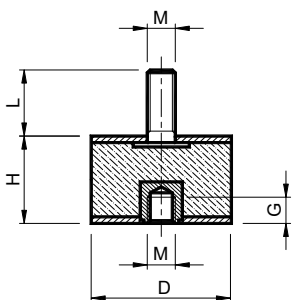

 Antivibration mounts made by rubber and steel parts
MATERIALS metal components are zincplated
 NR/SBR rubber compound
HARDNESS 55 SHORE +/-5%
USE male-female

 *Antivibranti gomma-metallo*
MATERIALI parti metalliche sono zincate
 Parti in gomma mescola NR/SBR
DUREZZA 55 SHORE +/-5%
IMPIEGO machio-femmina

Type Tipo	Cod. N°	D	H	L	G	M	Type Tipo	Cod. N°	D	H	L	G	M	Type Tipo	Cod. N°	D	H	L	G	M
MF2 6-7	AV001320	6	7	6	3	M3	1M1F2 25-25	AV001372	25	25	18	6	M6	1M1F2 50-40	AV001412	50	40	28	10	M10
MF2 8-8	AV001322	8	8	6	3	M3	MF2 25-28	AV001373	25	28	16	6	M6	1M1F2 50-45	AV001413	50	45	28	10	M10
MF2 10-7	AV001326	10	7	6	3	M3	1M1F2 25-30	AV001374	25	30	18	6	M6	1M1F2 50-50	AV001414	50	50	28	10	M10
1M1F2 10-10	AV001327	10	10	10	4	M4	1M1F2 30-15	AV001379	30	15	18	8	M8	1M1F2 60-30	AV001422	60	30	28	10	M10
1M1F2 10-15	AV001328	10	15	10	4	M4	1M1F2 30-20	AV001380	30	20	23	8	M8	1M1F2 60-30-M12	AV001423	60	30	37	12	M12
1M1F 13-10	AV001334	13	10	10	5	M5	1M1F 30-20-14	AV001381	30	20	14	8	M8	1M1F 60-35	AV001424	60	35	28	10	M10
MF2 15-8	AV001338	15	8	10	4	M4	1M1F2 30-25	AV001382	30	25	23	8	M8	MF2 60-40	AV001425	60	40	28	10	M10
MF2 15-8-6	AV001339	15	8	6	4	M4	1M1F2 30-30	AV001383	30	30	23	8	M8	1M1F2 60-40-M12	AV001426	60	40	28	12	M12
1M1F2 15-10	AV001340	15	10	10	4	M4	1M1F30-30-M6	AV001384	30	30	18	6	M6	1M1F 60-50	AV001427	60	50	35	10	M10
MF2 15-10 M5	AV001341	15	10	10	4	M5	1M1F2 30-40	AV001385	30	40	23	8	M8	1M1F 60-50-M12	AV001428	60	50	37	12	M12
1M1F2 15-15	AV001342	15	15	14	4	M4	MF2 40-15	AV001390	40	15	20	8	M8	1M1F2 65-35	AV001434	65	35	37	12	M12
MF2 15-15 M5	AV001343	15	15	8	6	M5	1M1F2 40-20	AV001391	40	20	23	8	M8	1M1F 65-50	AV001435	65	50	37	12	M12
MF2 15-20	AV001344	15	20	10	4	M4	MF2 40-20	AV001392	40	20	28	10	M10	1M1F2 70-45	AV001438	70	50	37	12	M12
MF2 15-30	AV001345	15	30	10	4	M4	1M1F2 40-25	AV001393	40	25	23	8	M8	1M1F2 75-25	AV001442	75	25	37	12	M12
1M1F 16-10	AV001349	16	10	12	5	M5	MF2 40-25-M10	AV001394	40	25	28	10	M10	1M1F2 75-40	AV001443	75	40	37	12	M12
1M1F 20-20	AV001354	20	10	16	6	M6	1M1F2 40-30	AV001395	40	30	23	8	M8	MF2 75-45	AV001444	75	45	37	12	M12
MF2 20-11	AV001355	20	11	18	6	M6	1M1F2 40-30-M10	AV001396	40	30	28	10	M10	1M1F2 75-50	AV001445	75	50	37	12	M12
1M1F2 20-15	AV001356	20	15	16	6	M6	1M1F 40-35	AV001397	40	35	23	8	M8	MF2 75-55	AV001446	75	55	37	12	M12
1M1F2 20-20	AV001357	20	20	16	6	M6	1M1F2 40-40	AV001398	40	40	23	8	M8	1M1F 100-30	AV001450	100	30	42	16	M16
1M1F2 20-25	AV001358	20	25	16	6	M6	1M1F2 40-40-M10	AV001399	40	40	28	10	M10	1M1F2 100-40	AV001451	100	40	42	16	M16
1M1F2 20-30	AV001359	20	30	16	6	M6	1M1F 40-45	AV001400	40	45	23	8	M8	1M1F2 100-50	AV001452	100	50	42	16	M16
1M1F2 25-15	AV001366	25	15	18	6	M6	1M1F2 50-20	AV001406	50	20	28	10	M10	1M1F2 100-55	AV001453	100	55	42	16	M16
1M1F 25-15-8	AV001367	25	15	8	6	M6	MF2 50-20-M8	AV001407	50	20	28	8	M8	1M1F2 100-60	AV001454	100	60	42	16	M16
1M1 25-15-M8	AV001368	25	15	18	6	M8	1M1F2 50-25	AV001408	50	25	28	10	M10	MF2 100-75	AV001455	100	75	41	16	M16
1M1F 25-18	AV001369	25	18	12	*	M5	1M1F2 50-30	AV001409	50	30	28	10	M10	MF2 150-50	AV001459	150	50	41	16	M16
1M1F2 25-20	AV001370	25	20	18	6	M6	MF2 50-30 M8	AV001410	50	30	23	8	M8	MF2 150-55	AV001460	150	55	41	16	M16
1M1 25-20-M8	AV001371	25	20	20	8	M8	MF2 50-35	AV001411	50	35	28	10	M10	MF2 150-75	AV001461	150	75	41	16	M16

Cylindrical Bobbins - Type: **MFT Hardness 45 SHORE** / *Antivibrante Cilindrico - Tipo: MFT Durezza 45 SHORE*

Type Tipo	Cod. N°	D	H	L	G	M
1M1F 20-25-10 SH45	AV001469	20	25	10	8	M6
1M1F 20-25-16 SH45	AV001470	20	25	16	6	M6
1M1F 25-15 SH45	AV001471	25	15	18	6	M6
1M1F 25-20 SH45	AV001472	25	20	18	6	M6
1M1F 30-30 SH45	AV001473	30	30	23	8	M8
1M1F 40-30 SH45	AV001474	40	30	23	8	M8

Type Tipo	Cod. N°	D	H	L	G	M
1M1F 40-30-M10 SH45	AV001475	40	30	28	10	M10
1M1F 50-30 SH45	AV001476	50	30	28	10	M10
1M1F 50-35 SH45	AV001477	50	35	28	10	M10
1M1F 50-50 SH45	AV001478	50	50	28	10	M10
1M1F 60-35 SH45	AV001479	60	35	30	10	M10
1M1F 75-50 SH45	AV001480	75	50	37	12	M12

Cylindrical Bobbins - Type: FF Hardness 55 SHORE / Antivibrante Cilindrico - Tipo: FF Durezza 55 SHORE

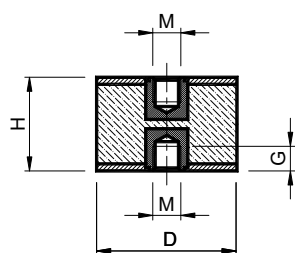

 Antivibraton mounts made by rubber and steel parts
MATERIALS metal components are zincplated
 NB/SBR rubber compound
HARDNESS 55 SHORE +/-5%
USE female-female

 Antivibranti gomma-metallo
MATERIALI parti metalliche sono zincate
 Parti in gomma miscela NR/SBR
DUREZZA 55 SHORE +/-5%
IMPIEGO femmina-femmina

Type Tipo	Cod. N°	D	H	G	M
F3 08-08	AV001556	8	8	3	M3
F3 10-10	AV001558	10	10	4	M4
F3 10-15	AV001559	10	15	4	M4
F3 10-15-M3	AV001560	10	15	5	M3
F3 15-10	AV001564	15	10	4	M4
2F3 15-15	AV001565	15	15	4	M4
F3 15-15-M5	AV001566	15	15	5	M5
F3 15-20	AV001567	15	20	5	M4
F3 15-25	AV001568	15	25	4	M4
F3 15-30	AV001569	15	30	4	M4
2F3 20-15	AV001574	20	15	6	M6
2F3 20-20	AV001575	20	20	6	M6
F3 20-20-M5	AV001576	20	20	5	M5
2F3 20-25	AV001577	20	25	6	M6
2F 20-30	AV001578	20	30	6	M6
2F 25-15	AV001582	25	15	*	M6
2F3 25-20	AV001583	25	20	6	M6
2F3 25-25	AV001584	25	25	6	M6
2F3 25-30	AV001585	25	30	6	M6
2F3 30-20	AV001589	30	20	8	M8
F3 30-25	AV001590	30	25	8	M8
2F3 30-30	AV001591	30	30	8	M8
2F3 30-40	AV001592	30	40	8	M8
2F3 40-30	AV001597	40	30	8	M8
2F3 40-30-M10	AV001598	40	30	10	M10
2F3 40-35	AV001599	40	35	8	M8
2F3 40-40	AV001600	40	40	8	M8
2F 40-40	AV001601	40	40	10	M10
2F3 50-30	AV001608	50	30	10	M10
2F3 50-40	AV001609	50	40	10	M10

Type Tipo	Cod. N°	D	H	G	M
F3 50-45	AV001610	50	45	10	M10
2F3 50-50	AV001611	50	50	10	M10
F3 50-60	AV001612	50	60	10	M10
2F3 60-30	AV001620	60	30	10	M10
2F3 60-30-M12	AV001621	60	30	12	M12
F3 60-40	AV001622	60	40	10	M10
2F3 60-40-M12	AV001623	60	40	12	M12
2F 60-50	AV001624	60	50	10	M10
F3 65-35	AV001627	65	35	8	M8
F3 70-35	AV001631	70	35	10	M10
F3 70-45	AV001632	70	45	10	M10
F3 70-50	AV001633	70	50	10	M10
2F 75-30	AV001636	75	30	12	M12
2F3 75-40	AV001637	75	40	12	M12
F3 75-45	AV001638	75	45	12	M12
2F3 75-50	AV001639	75	50	12	M12
F3 75-55	AV001640	75	55	12	M12
F3 100-40	AV001647	100	40	16	M16
2F3 100-50	AV001648	100	50	16	M16
2F3 100-55	AV001649	100	55	16	M16
2F3 100-60	AV001650	100	60	16	M16
F3 100-75	AV001651	100	75	16	M16
F3 150-50	AV001656	150	50	16	M16
F3 150-50-M20	AV001657	150	50	18	M20
F3 150-55	AV001658	150	55	16	M16
F3 150-55-M20	AV001659	150	55	18	M20
F3 150-75	AV001660	150	75	16	M16
F3 150-75-M20	AV001661	150	75	18	M20
F3 200-100	AV001666	200	100	18	M20
F3 200-100-M16	AV001667	200	100	16	M16

Cylindrical Bobbins - Type: **PM Hardness 55 SHORE** / *Antivibrante Cilindrico - Tipo: **PM Durezza 55 SHORE***

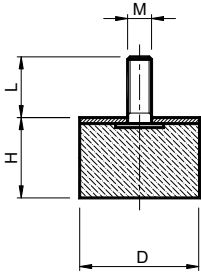

 Antivibration mounts made by rubber and steel parts
MATERIALS metal components are zincplated
 NR/SBR rubber compound
HARDNESS 55 SHORE +/-5%
USE male-rubber foot

 *Antivibranti gomma-metallo*
MATERIALI parti metalliche sono zincate
 Parti in gomma mescola NR/SBR
DUREZZA 55 SHORE +/-5%
IMPIEGO maschio-piede antivibrante

Type Tipo	Cod. N°	D	H	L	M
PM4 06-07	AV001792	6	7	6	M3
PM4 08-08	AV001795	8	8	6	M3
PM4 10-08	AV001798	10	8	10	M4
PM4 10-10	AV001799	10	10	10	M4
PM4 10-15	AV001800	10	15	10	M4
PM4 15-04	AV001805	15	4	8	M4
M4 15-05	AV001806	15	5	6	M4
PM4 15-07	AV001807	15	7	10	M4
PM4 15-08	AV001808	15	8	10	M4
1P1M4 15-10	AV001809	15	10	10	M4
PM4 15-13	AV001810	15	13	13	M4
1P1M4 15-10	AV001811	15	15	14	M4
PM4 15-20	AV001812	15	20	10	M4
PM4 15-30	AV001813	15	30	10	M4
1P1M 16-10	AV001816	16	10	12	M5
PM4 20-05	AV001820	20	5	18	M6
1P1M4 20-08	AV001821	20	8.5	10	M6
1P1M4 20-10	AV001822	20	10	16	M6
PM4 20-11	AV001823	20	11	18	M6
PM4 20-12	AV001824	20	12	20	M6
PM4 20-13.5	AV001825	20	13.5	18	M6
1P1M4 20-15	AV001826	20	15	16	M6
1P1M4 20-20	AV001827	20	20	16	M6
1P1M4 20-25	AV001828	20	25	16	M6
1P1M 20-10	AV001829	20	30	16	M6
PM4 20-37	AV001830	20	37	18	M6
PM4 25-08	AV001834	25	8	18	M6
PM4 25-10	AV001835	25	10	18	M6
PM4 25-13	AV001836	25	13	18	M6
1P1M4 25-15	AV001837	25	15	18	M6
PM4 25-18	AV001838	25	18	18	M6
1P1M4 25-20	AV001839	25	20	18	M6

Type Tipo	Cod. N°	D	H	L	M
1P1M 25-20-M8	AV001840	25	20	20	M8
1P1M4 25-25	AV001841	25	25	18	M6
1P1M4 25-30	AV001842	25	30	18	M6
1P1M 25-30-M8	AV001843	25	30	20	M8
1P1M 25-30-30	AV001844	25	30	30	M8
PM4 30-08	AV001851	30	8	20	M8
1P1M4 30-10	AV001852	30	10	18	M6
1P1M 30-10-M8	AV001853	30	10	23	M8
1P1M 30-10-M8-40	AV001854	30	10	40	M8
1P1M4 30-15	AV001855	30	15	23	M8
PM4 30-17	AV001856	30	17	20	M8
1P1M4 30-20	AV001857	30	20	23	M8
1P1M4 30-25	AV001858	30	25	23	M8
1P1M4 30-30	AV001859	30	30	23	M8
1P1M4 30-40	AV001860	30	40	23	M8
PM4 30-45	AV001861	30	45	20	M8
PM4 40-10	AV001866	40	10	23	M8
PM4 40-15	AV001867	40	15	23	M8
1P1M4 40-20	AV001868	40	20	23	M8
PM4 40-25	AV001869	40	25	23	M8
PM4 40-27	AV001870	40	27	20	M8
PM4 40-28	AV001871	40	28	23	M8
1P1M 40-30-M8	AV001872	40	30	23	M8
1P1M 40-30-M10	AV001873	40	30	28	M10
1P1M 40-35-M8	AV001874	40	35	23	M8
PM4 40-38	AV001875	40	38	23	M8
1P1M 40-40-M8	AV001876	40	40	23	M8
1P1M 40-40-M10	AV001877	40	40	28	M10
PM4 40-50	AV001878	40	50	23	M8
PM4 50-17	AV001884	50	17	28	M10
1P1M4 50-20	AV001885	50	20	28	M10
PM4 50-25	AV001886	50	25	28	M10

Type Tipo	Cod. N°	D	H	L	M
PM4 50-28	AV001887	50	28	28	M10
1P1M4 50-30	AV001888	50	30	28	M10
PM4 50-35	AV001889	50	35	28	M10
1P1M4 50-40	AV001890	50	40	28	M10
1P1M4 50-45	AV001891	50	45	28	M10
1P1M4 50-50	AV001892	50	50	28	M10
1P1M 60-20-M10	AV001895	60	20	28	M10
1P1M 60-20-M12	AV001896	60	20	37	M12
PM4 60-30	AV001897	60	30	28	M10
1P1M 60-30-M12	AV001898	60	30	37	M12
PM4 60-40	AV001899	60	40	28	M10
1P1M 60-40-M12	AV001900	60	40	37	M12
1P1M 60-50-M10	AV001901	60	50	37	M10
1P1M 60-50-M12	AV001902	60	50	37	M12
PM4 70-25-M10	AV001910	70	25	28	M10
1P1M 70-25-M12	AV001911	75	25	37	M12
PM4 70-45	AV001912	70	45	28	M10
PM4 70-50	AV001913	70	50	37	M12
PM4 75-25	AV001918	75	25	37	M12
1P1M4 75-40	AV001919	75	40	37	M12
PM4 75-45	AV001920	75	45	37	M12
1P1M4 75-50	AV001921	75	50	37	M12
PM4 75-55	AV001922	75	55	37	M12
1P1M4 100-40	AV001926	100	40	42	M16
1P1M4 100-50	AV001927	100	50	42	M16
PM4 100-55	AV001928	100	55	41	M16
PM4 100-60	AV001929	100	60	41	M16
PM4 100-75	AV001930	100	75	41	M16
PM4 150-50	AV001935	150	50	41	M16
PM4 150-60	AV001937	150	60	41	M16
PM4 150-75	AV001938	150	75	41	M16

Cylindrical Bobbins - Type: **PMT Hardness 45 SHORE** / *Antivibrante Cilindrico - Tipo: **PMT Durezza 45 SHORE***

Type Tipo	Cod. N°	D	H	L	M
1P1M 30-20 SH45	AV001948	30	20	20	M8
1P1M 30-30 SH45	AV001949	30	30	20	M8
1P1M 40-30 SH45	AV001951	40	30	23	M8
1P1M 40-40 SH45	AV001952	40	40	23	M8
1P1M 50-40 SH45	AV001954	50	40	20	M10

Cylindrical Bobbins - Type: **PF Hardness 55 SHORE** / *Antivibrante Cilindrico - Tipo: PF Durezza 55 SHORE*

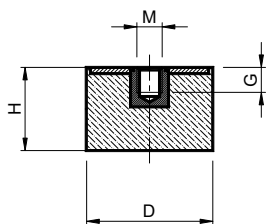



 Antivibration mounts made by rubber and steel parts
MATERIALS metal components are zincplated
 NR/SBR rubber compound
HARDNESS 55 SHORE +/-5%
USE female-rubber foot

 *Antivibranti gomma-metallo*
MATERIALI parti metalliche sono zincate
 Parti in gomma mescola NR/SBR
DUREZZA 55 SHORE +/-5%
IMPIEGO femmina-piede antivibrante

Type Tipo	Cod. N°	D	H	G	M
PF5 08-08	AV002000	8	8	3	M3
PF5 10-10	AV002003	10	10	4	M4
PF5 10-15	AV002004	10	15	4	M4
PF5 15-10	AV002010	15	10	4	M4
PF5 15-15	AV002011	15	15	4	M4
PF5 15-15-M5	AV002012	15	15	5	M5
PF5 20-10	AV002015	20	10	6	M6
PF5 20-11	AV002016	20	11	6	M6
PF5 20-12	AV002017	20	12	6	M6
PF5 20-13,5	AV002018	20	13,5	6	M6
1P1F5 20-15	AV002019	20	15	6	M6
1P1F5 20-20	AV002020	20	20	6	M6
PF5 20-25	AV002021	20	25	6	M6
PF5 25-10	AV002027	25	10	6	M6
1P1F5 25-15	AV002028	25	15	6	M6
1P1F 25-18	AV002029	25	18	9	M6
PF5 25-20	AV002030	25	20	6	M6
PF5 25-25	AV002031	25	25	6	M6
PF5 25-28	AV002032	25	28	6	M6
PF5 25-30	AV002033	25	30	6	M6
PF5 30-15	AV002039	30	15	8	M8
PF5 30-17	AV002040	30	17	8	M8
1P1F5 30-20	AV002041	30	20	8	M8
PF5 30-25	AV002042	30	25	8	M8
1P1F5 30-30	AV002043	30	30	8	M8
PF5 30-40	AV002044	30	40	8	M8
PF5 40-20	AV002051	40	20	8	M8
PF5 40-20-M10	AV002052	40	20	10	M10
PF5 40-25	AV002053	40	25	8	M8
PF5 40-30	AV002054	40	30	8	M8
PF5 40-30-M10	AV002055	40	30	10	M10
PF5 40-40	AV002056	40	40	8	M8

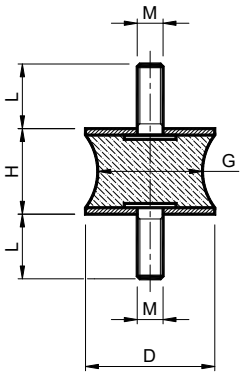
Type Tipo	Cod. N°	D	H	G	M
1P1F5 50-20	AV002064	50	20	10	M10
PF5 50-25	AV002065	50	25	10	M10
PF5 50-28	AV002066	50	28	10	M10
1P1F5 50-30	AV002067	50	30	9	M10
PF5 50-35	AV002068	50	35	10	M10
1P1F5 50-40	AV002069	50	40	10	M10
PF5 50-45	AV002070	50	45	10	M10
1P1F5 50-50	AV002071	50	50	10	M10
1P1F5 60-30-M10	AV002078	60	30	10	M12
PF5 60-30-M12	AV002079	60	30	12	M12
PF5 60-40	AV002080	60	40	10	M10
PF5 60-40-M12	AV002081	60	40	12	M12
PF5 70-25	AV002086	70	25	10	M10
PF5 70-30	AV002087	70	30	10	M10
PF5 70-45	AV002088	70	45	10	M10
1P1F5 75-25	AV002096	75	25	12	M12
PF5 75-40	AV002097	75	40	12	M12
PF5 75-45	AV002098	75	45	12	M12
1P1F5 75-50	AV002099	75	50	12	M12
PF5 75-55	AV002100	75	55	12	M12
PF5 100-40	AV002108	100	40	16	M16
PF5 100-50	AV002109	100	50	16	M16
PF5 100-55	AV002110	100	55	16	M16
PF5 100-60	AV002111	100	60	16	M16
PF5 100-75	AV002112	100	75	16	M16
PF5 150-45	AV002122	150	45	16	M16
PF5 150-50	AV002123	150	50	16	M16
PF5 150-55	AV002124	150	55	16	M16
PF5150-60	AV002125	150	60	16	M16
PF5 150-75	AV002126	150	75	16	M16
PF5 150-100	AV002127	150	100	20	M20

Waisted Bobbins - Type: AT Hardness 55 SHORE / Antivibrante Sgolato - Tipo: AT Durezza 55 SHORE



 Antivibration mounts made by rubber and steel parts
MATERIALS metal components are zincplated
 NR/SBR rubber compound
HARDNESS 55 SHORE +/-5%
USE male-male

 *Antivibranti gomma-metallo*
MATERIALI parti metalliche sono zincate
 Parti in gomma mescola NR/SBR
DUREZZA 55 SHORE +/-5%
IMPIEGO maschio-maschio

Type Tipo	Cod. N°	D	H	G	L	M
AT 10-10	AV002288	10	10	10	8	M4
A2M 12-15	AV002292	12	15	7	10	M4
AT 20-15	AV002296	20	15	18	14	M6
AT 20-19	AV002297	20	19	15	14	M6
AT 20-30	AV002298	20	30	12	12	M6
AT 20-40	AV002299	20	40	12	15	M6
AT2M 25-20	AV002304	25	20	10	18	M6
AT2M 30-20	AV002310	30	20	20	20	M8
AT 30-25	AV002311	30	25	15	23	M8
AT 40-28	AV002318	40	28	28	35	M10

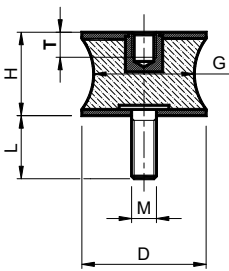
Type Tipo	Cod. N°	D	H	G	L	M
AT2M 40-30	AV002319	40	30	19	20	M8
A2M 40-30-27	AV002320	40	30	27	20	M8
AT 40-48	AV002321	40	48	23	20	M8
AT 46-25	AV002325	46	25	20	40	M10
AT 50-30	AV002330	50	30	33	41	M10
AT 60-60	AV002335	60	60	28	49	M10
AT 75-40	AV002339	75	40	37	54	M12
AT 100-55	AV002344	100	55	43	80	M16
AT 100-75	AV002345	100	75	41	95	M16

Waisted Bobbins - Type: BT Hardness 55 SHORE / Antivibrante Sgolato - Tipo: BT Durezza 55 SHORE

 Antivibration mounts made by rubber and steel parts
MATERIALS metal components are zincplated
 NR/SBR rubber compound
HARDNESS 55 SHORE +/-5%
USE female-male

 *Antivibranti gomma-metallo*
MATERIALI parti metalliche sono zincate
 Parti in gomma mescola NR/SBR
DUREZZA 55 SHORE +/-5%
IMPIEGO femmina-maschio

Type Tipo	Cod. N°	D	H	G	L	T	M
BT 10-10	AV002402	10	10	10	4	8	M4
BT 15-15	AV002405	15	15	12	5	12	M6
BT 20-15	AV002408	20	15	18	6	14	M6
BT 20-19	AV002409	20	19	10	6	14	M6
BT 25-20	AV002412	25	20	18	6	18	M6
BT 30-20	AV002415	30	20	20	8	25	M8
BT 40-30-M8	AV002417	40	30	23	8	25	M8
BT 40-30-M10	AV002418	40	30	20	10	25	M10
BT 55-45	AV002421	55	45	28	10	46	M10
BT 60-60	AV002424	60	60	28	10	49	M10

Waisted Bobbins - Type: **CT** Hardness **55 SHORE** / Antivibrante Sgolato - Tipo: **CT Durezza 55 SHORE**

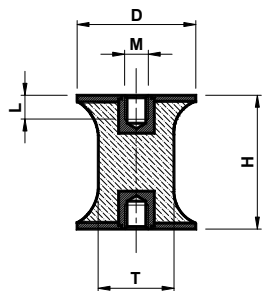

 Antivibration mounts made by rubber and steel parts

MATERIALS metal components are zincplated

NR/SBR rubber compound

HARDNESS 55 SHORE +/-5%

USE female-female

 Antivibranti gomma-metallo

MATERIALI parti metalliche sono zincate

Parti in gomma mescola NR/SBR

DUREZZA 55 SHORE +/-5%

IMPIEGO femmina-femmina

Type Tipo	Cod. N°	D	H	L	T	M
CT 10-10	AV002456	10	10	4	8	M4
CT 20-30	AV002459	20	30	6	14	M6
CT 30-20	AV002462	30	20	8	25	M8
CT 40-30	AV002465	40	30	8	33	M8
CT 40-48	AV002466	40	48	8	20	M8
CT 50-30	AV002469	50	30	10	41	M10
CT 60-60	AV002472	60	60	10	49	M10
CT 70-53	AV002475	70	53	10	45	M10
CT 75-40	AV002478	75	40	12	54	M12
CT 100-55	AV002481	100	55	18	80	M16

Conical Bobbins - Type: **CN** Hardness **55 SHORE** / Antivibrante Conico - Tipo: **CN Durezza 55 SHORE**

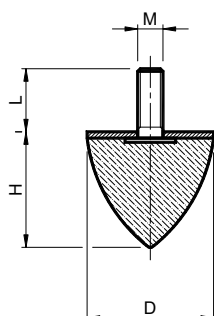

 Antivibration mounts made by rubber and steel parts

MATERIALS metal components are zincplated

NR/SBR rubber compound

HARDNESS 55 SHORE +/-5%

USE male-rubber foot

 Antivibranti gomma-metallo

MATERIALI parti metalliche sono zincate

Parti in gomma mescola NR/SBR

DUREZZA 55 SHORE +/-5%

IMPIEGO maschio-piede antivibrante

Type Tipo	Cod. N°	D	H	G	M
CKP 10-10	AV002555	10	10	12	M5
CKP 15-15	AV002559	15	15	10	M5
CKP 20-15	AV002563	20	15	18	M6
CKP 20-24	AV002564	20	24	18	M6
CKP 25-20	AV002569	25	20	18	M6
A2C 25-22-M6	AV002570	25	22	20	M6
A2C 25-22-M10	AV002571	25	22	20	M10
A2C 25-25	AV002572	25	25	18	M6
A2C 25-25 45SH	AV002573	25	25	18	M6
A2C 25-30	AV002574	25	30	18	M6
CKP 30-30	AV002578	30	30	20	M8
A2CKP 30-36	AV002579	30	36	23	M8
CKP 35-40	AV002582	35	40	20	M8
A2C 40-30	AV002585	40	30	23	M8
A2C 40-60	AV002586	40	60	23	M8

Type Tipo	Cod. N°	D	H	G	M
CKP 50-50-M8	AV002590	50	50	36	M8
A2C 50-50-M10	AV002591	50	50	28	M10
CKP 50-58	AV002592	50	58	28	M10
CKP 50-61	AV002593	50	61	26	M8
A2C 50-64	AV002594	50	64	35	M8
CKP 50-67	AV002595	50	67	36	M8
A2C 60-60	AV002598	60	60	33	M12
CKP 70-60	AV002601	70	60	35	M12
A2C 75-70	AV002604	75	70	37	M12
CKP 75-89	AV002605	75	89	37	M12
CKP 95-80	AV002608	95	80	42	M16
A2C 100-85	AV002611	100	85	42	M16
CKP 115-136	AV002614	115	136	43	M16
CKP 165-195	AV002617	165	195	43	M16

Cylindrical Bobbins - Type: **MMX Hardness 55 SHORE** / *Antivibrante Cilindrico - Tipo: **MMX Durezza 55 SHORE***

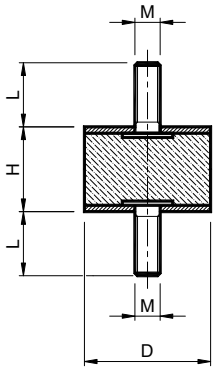

 Antivibration mounts made by rubber and steel parts
MATERIALS metal components are in stainless steel
 NR/SBR rubber compound
HARDNESS 55 SHORE +/-5%
USE male-male

 *Antivibranti gomma-metallo*
MATERIALI parti metalliche sono inox
 Parti in gomma mescola NR/SBR
DUREZZA 55 SHORE +/-5%
IMPIEGO maschio-maschio

Type Tipo	Cod. N°	D	H	L	M
M1X 06-07	AV001202	6	7	6	M3
M1X 08-08	AV001205	8	8	6	M3
M1X 10-08	AV001208	10	8	10	M4
M1X 10-10	AV001209	10	10	10	M4
M1X 10-15	AV001210	10	15	10	M4
M1X 15-6	AV001213	15	6	10	M4
M1X 15-7	AV001214	15	7	10	M4
M1X 15-8	AV001215	15	8	10	M4
M1X 15-10	AV001216	15	10	10	M4
M1X 13-13	AV001219	15	13	13	M4
M1X 15-15	AV001223	15	15	10	M4
M1X 15-15-M5	AV001224	15	15	8	M5
M1X 15-20	AV001225	15	20	10	M4
M1X 15-30	AV001226	15	30	10	M4
M1X 20-8	AV001230	20	8	18	M6
M1X 20-10	AV001231	20	10	18	M6
M1X 20-15	AV001232	20	15	18	M6
M1X 20-20	AV001233	20	20	18	M6
M1X 20-25	AV001234	20	25	18	M6
M1X 20-30	AV001235	20	30	8	M6
M1X 25-10	AV001240	25	10	18	M6
M1X 25-15	AV001241	25	15	18	M6
M1X 25-18	AV001242	25	18	18	M6
M1X 25-20	AV001243	25	20	18	M6
M1X 25-25	AV001244	25	25	18	M6
M1X 25-30	AV001245	25	30	18	M6
M1X 30-10	AV001250	30	10	20	M8
M1X 30-15	AV001251	30	15	12	M8
2MX 30-15-14	AV001252	30	15	14	M8
M1X 30-20	AV001253	30	20	20	M8
M1X 30-25	AV001254	30	25	20	M8
M1X 30-30	AV001255	30	30	20	M8

Type Tipo	Cod. N°	D	H	L	M
M1X 30-40	AV001256	30	40	20	M8
M1X 40-15	AV001261	40	15	20	M8
M1X 40-15-M10	AV001262	40	20	23	M8
M1X 40-20	AV001263	40	20	28	M10
M1X 40-25	AV001264	40	25	23	M8
M1X 40-25-M10	AV001265	40	25	28	M10
M1X 40-30	AV001266	40	30	23	M8
M1X 40-30-M10	AV001267	40	30	28	M10
M1X 40-35	AV001268	40	35	23	M8
M1X 40-40	AV001269	40	40	23	M8
M1X 50-20	AV001274	50	20	28	M10
M1X 50-25	AV001275	50	25	28	M10
M1X 50-30	AV001276	50	30	28	M10
M1X 50-35	AV001277	50	35	28	M10
M1X 50-40	AV001278	50	40	28	M10
M1X 50-45	AV001279	50	45	33	M10
M1X 50-50	AV001280	50	50	28	M10
M1X 60-30	AV001286	60	30	28	M10
M1X 60-40	AV001288	60	40	28	M10
M1X 70-45	AV001292	70	45	28	M10
M1X 75-25	AV001296	75	25	37	M12
M1X 75-40	AV001297	75	40	37	M12
M1X 75-50	AV001298	75	50	37	M12
M1 75-55	AV001299	75	55	37	M12
M1X 100-40	AV001304	100	40	41	M16
M1X 100-50	AV001305	100	50	41	M16
M1X100-55	AV001306	100	55	41	M16
M1X 100-60	AV001307	100	60	41	M16
M1X 100-75	AV001308	100	75	41	M16
M1X 150-50	AV001313	150	50	41	M16
M1X 150-55	AV001314	150	55	41	M16
M1X 150-75	AV001315	150	75	41	M16

Cylindrical Bobbins - Type: **MF2X Hardness 55 SHORE** / *Antivibrante Cilindrico - Tipo: MF2X Durezza 55 SHORE*

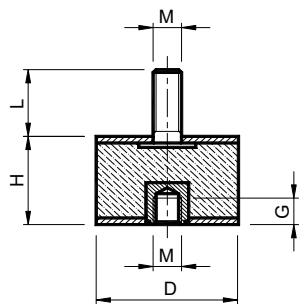

 Antivibration mounts made by rubber and steel parts
MATERIALS metal components are in stainless steel
 NR/SBR rubber compound
HARDNESS 55 SHORE +/-5%
USE male-female

 *Antivibranti gomma-metallo*
MATERIALI parti metalliche sono inox
 Parti in gomma mescola NR/SBR
DUREZZA 55 SHORE +/-5%
IMPIEGO maschio-femmina

Type Tipo	Cod. N°	D	H	L	G	M
MF2X 06-07	AV001483	6	7	6	3	M3
MF2X 08-08	AV001487	8	8	6	3	M3
MF2X 10-07	AV001490	10	7	6	3	M3
MF2X 10-10	AV001491	10	10	10	4	M4
MF2X 10-15	AV001492	10	15	10	4	M4
MF2X 15-8	AV001497	15	8	10	4	M4
MF2X 15-8-6	AV001498	15	8	6	4	M4
MF2X 15-10	AV001499	15	10	10	4	M4
MF2X 15-10-M5	AV001500	15	10	10	4	M5
MF2X 15-15	AV001501	15	15	10	6	M4
MF2X 15-15-M5	AV001502	15	15	8	6	M5
MF2X 15-20	AV001503	15	20	10	4	M4
MF2X 15-30	AV001504	15	30	10	4	M4
MF2X 20-15	AV001517	20	15	18	6	M6
MF2X 20-20	AV001518	20	20	18	6	M6
MF2X 20-25	AV001519	20	25	18	6	M6
MF2X 20-30	AV001520	20	30	18	6	M6
MF2X 25-15	AV001525	25	15	18	6	M6

Type Tipo	Cod. N°	D	H	L	G	M
MF2X 25-20	AV001526	25	20	18	6	M6
MF2X 25-25	AV001527	25	25	18	6	M6
MF2X 25-28	AV001528	25	28	16	6	M6
MF2X 25-30	AV001529	25	30	18	6	M6
MF2X 30-15	AV001533	30	15	20	8	M8
MF2X 30-20	AV001534	30	20	20	8	M8
MF2X 30-25	AV001535	30	25	20	8	M8
MF2X 30-30	AV001536	30	30	20	8	M8
MF2X 30-40	AV001537	30	40	20	8	M8
MF2X 40-15	AV001542	40	15	20	8	M8
MF2X 40-20	AV001543	40	20	23	8	M8
MF2X 40-20-M10	AV001544	40	20	28	10	M10
MF2X 40-25	AV001545	40	25	23	8	M8
MF2X 40-25-M10	AV001546	40	25	28	10	M10
MF2X 40-30	AV001547	40	30	23	8	M8
MF2X 40-30-M10	AV001548	40	30	28	10	M10
MF2X 40-40	AV001549	40	40	23	8	M8
MF2X 40-40-M10	AV001550	40	40	23	10	M10

Cylindrical Bobbins - Type: **FFX Hardness 55 SHORE** / *Antivibrante Cilindrico - Tipo: FFX Durezza 55 SHORE*

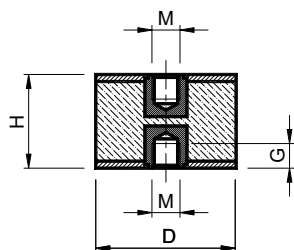

 Antivibration mounts made by rubber and steel parts
MATERIALS metal components are in stainless steel
 NR/SBR rubber compound
HARDNESS 55 SHORE +/-5%
USE female-female

 *Antivibranti gomma-metallo*
MATERIALI parti metalliche sono inox
 Parti in gomma mescola NR/SBR
DUREZZA 55 SHORE +/-5%
IMPIEGO femmina-femmina

Type Tipo	Cod. N°	D	H	G	M
F3X 08-08	AV001674	8	8	3	M3
F3X 10-10	AV001677	10	10	4	M4
F3X 10-15	AV001678	10	15	4	M4
F3X 15-15	AV001681	15	15	5	M4
F3X 15-15-M5	AV001682	15	15	5	M5
F3X 15-20	AV001683	15	20	5	M4
F3X 15-25	AV001684	15	25	4	M4
F3X 15-30	AV001685	15	30	4	M4
F3X 20-15	AV001689	20	15	6	M6
F3X 20-20	AV001690	20	20	6	M6
F3X 20-25	AV001691	20	25	6	M6
F3X 25-20	AV001696	25	20	6	M6
F3X 25-25	AV001697	25	25	6	M6
F3X 25-30	AV001698	25	30	6	M6
F3X 30-20	AV001703	30	20	8	M8
F3X 30-25	AV001704	30	25	8	M8
F3X 30-30	AV001705	30	30	8	M8
F3X 30-40	AV001706	30	40	8	M8
F3X 40-25	AV001711	40	25	8	M8
F3X 40-30	AV001712	40	30	8	M8
F3X 40-30-M10	AV001713	40	30	10	M10
F3X 40-35	AV001714	40	35	8	M8
F3X 40-40	AV001715	40	40	8	M8
F3X 50-30	AV001720	50	30	10	M10
F3X 50-40	AV001721	50	40	10	M10
F3X 50-45	AV001722	50	45	10	M10

Type Tipo	Cod. N°	D	H	G	M
F3X 50-50	AV001723	50	50	10	M10
F3X 50-60	AV001724	50	60	10	M10
F3X 60-30	AV001729	60	30	10	M10
F3X 60-30-M12	AV001730	60	30	12	M12
F3X 60-40	AV001731	60	40	10	M10
F3X 60-40-M12	AV001732	60	40	12	M12
F3X 70-35	AV001736	70	35	10	M10
F3X 70-45	AV001737	70	45	10	M10
F3X 70-50	AV001738	70	50	10	M10
F3X 75-40	AV001743	75	40	12	M12
F3X 75-45	AV001744	75	45	12	M12
F3X 75-50	AV001745	75	50	12	M12
F3X 75-55	AV001746	75	55	12	M12
F3X 100-40	AV001751	100	40	16	M16
F3X 100-50	AV001752	100	50	16	M16
F3X 100-55	AV001753	100	55	16	M16
F3X 100-60	AV001754	100	60	16	M16
F3X 100-75	AV001755	100	75	16	M16
F3X 150-50	AV001762	150	50	16	M16
F3X 150-50-M20	AV001763	150	50	18	M20
F3X 150-55	AV001764	150	55	16	M16
F3X 150-55-M20	AV001765	150	55	18	M20
F3X 150-75	AV001766	150	75	16	M16
F3X 150-75-M20	AV001767	150	75	18	M20
F3X 200-100	AV001776	200	100	18	M20
F3X 200-100-M16	AV001777	200	100	16	M16

Cylindrical Bobbins - Type: **PMX Hardness 55 SHORE** / *Antivibrante Cilindrico - Tipo: **PMX Durezza 55 SHORE***

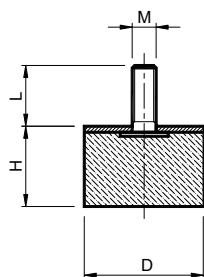



 Antivibration mounts made by rubber and steel parts
MATERIALS metal components are in stainless steel
 NR/SBR rubber compound
HARDNESS 55 SHORE +/-5%
USE male-rubber foot

 *Antivibranti gomma-metallo*
MATERIALI parti metalliche sono inox
 Parti in gomma mescola NR/SBR
DUREZZA 55 SHORE +/-5%
IMPIEGO maschio-piede antivibrante

Type Tipo	Cod. N°	D	H	L	M
PM4X 06-07	AV001960	6	7	6	M3
PM4X 08-08	AV001962	8	8	6	M3
PM4X 10-08	AV001964	10	8	10	M4
PM4X 10-10	AV001965	10	10	10	M4
PM4X 10-15	AV001966	10	15	10	M4
PM4X 15-04	AV001969	15	4	8	M4
PM4X 15-05	AV001970	15	5	6	M4
PM4X 15-07	AV001971	15	7	10	M4
PM4X 15-08	AV001972	15	8	10	M4
PM4X 15-10	AV001973	15	10	10	M4
PM4X 15-13	AV001974	15	13	13	M4
1P1M4X 15-15	AV001975	15	15	14	M4
PM4X 15-20	AV001976	15	20	10	M4
PM4X 15-30	AV001977	15	30	10	M4
PM4X 20-05	AV001982	20	5	18	M6
1P1MX 20-15	AV001983	20	15	16	M6
1P1MX 25-20	AV001987	25	20	18	M6
1P1MX 30-30	AV001990	30	30	23	M8
1P1MX 40-30	AV001994	40	30	23	M8

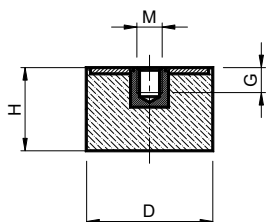
Cylindrical Bobbins - Type: **PFX Hardness 55 SHORE** / *Antivibrante Cilindrico - Tipo: PFX Durezza 55 SHORE*



 Antivibration mounts made by rubber and steel parts
MATERIALS metal components are in stainless steel
 NR/SBR rubber compound
HARDNESS 55 SHORE +/-5%
USE female-rubber foot

 *Antivibranti gomma-metallo*
MATERIALI parti metalliche sono inox
 Parti in gomma mescola NR/SBR
DUREZZA 55 SHORE +/-5%
IMPIEGO femmina-piede antivibrante

Type Tipo	Cod. N°	D	H	G	M
PF5X 08-08	AV002150	8	8	3	M3
PF5X 10-10	AV002153	10	10	4	M4
PF5X 10-15	AV002154	10	15	4	M4
PF5X 15-10	AV002159	15	10	4	M4
PF5X 15-15-M4	AV002160	15	15	4	M4
PF5X 15-15-M5	AV002161	15	15	5	M5
PF5X 20-10	AV002166	20	10	6	M6
PF5X 20-11	AV002167	20	11	6	M6
PF5X 20-12	AV002168	20	12	6	M6
PF5X 20-13.5	AV002169	20	13,5	6	M6
PF5X 20-15	AV002170	20	15	6	M6
PF5X 20-20	AV002171	20	20	6	M6
PF5X 20-25	AV002172	20	25	6	M6
PF5X 25-10	AV002179	25	10	6	M6
PF5X 25-15	AV002180	25	15	6	M6
PF5X 25-20	AV002181	25	20	6	M6
PF5X 25-25	AV002182	25	25	6	M6
PF5X 25-28	AV002183	25	28	6	M6
PF5X 25-30	AV002184	25	30	6	M6
PF5X 30-15	AV002192	30	15	8	M8
PF5X 30-17	AV002193	30	17	8	M8
PF5X 30-20	AV002194	30	20	8	M8
PF5X 30-25	AV002195	30	25	8	M8
PF5X 30-30	AV002196	30	30	8	M8
PF5X 30-40	AV002197	30	40	8	M8
PF5X 40-20-M8	AV002205	40	20	8	M8
PF5X 40-20-M10	AV002206	40	20	10	M10
PF5X 40-25	AV002207	40	25	8	M8
PF5X 40-30-M8	AV002208	40	30	8	M8
PF5X 40-30-M10	AV002209	40	30	10	M10
PF5X 40-40	AV002210	40	40	8	M8

Type Tipo	Cod. N°	D	H	G	M
PF5X 50-20	AV002220	50	20	10	M10
PF5X 50-25	AV002221	50	25	10	M10
PF5X 50-28	AV002222	50	28	10	M10
PF5X 50-30	AV002223	50	30	10	M10
PF5X 50-35	AV002224	50	35	10	M10
PF5X 50-40	AV002225	50	40	10	M10
PF5X 50-45	AV002226	50	45	10	M10
PF5X 50-50	AV002227	50	50	10	M10
PF5X 60-30-M10	AV002232	60	30	10	M10
PF5X 60-30-M12	AV002233	60	30	12	M12
PF5X 60-40-M10	AV002234	60	40	10	M10
PF5X 60-40-M12	AV002235	60	40	12	M12
PF5X 70-25	AV002242	70	25	10	M10
PF5X 70-30	AV002243	70	30	10	M10
PF5X 70-45	AV002244	70	45	10	M10
PF5X 75-25	AV002252	75	25	12	M12
PF5X 75-40	AV002253	75	40	12	M12
PF5X 75-45	AV002254	75	45	12	M12
PF5X 75-50	AV002255	75	50	12	M12
PF5X 75-55	AV002256	75	55	12	M12
PF5X 100-40	AV002264	100	40	16	M16
PF5X 100-50	AV002265	100	50	16	M16
PF5X 100-55	AV002266	100	55	16	M16
PF5X 100-60	AV002267	100	60	16	M16
PF5X 100-75	AV002268	100	75	16	M16
PF5X 150-45	AV002277	150	45	16	M16
PF5X 150-50	AV002278	150	50	16	M16
PF5X 150-55	AV002279	150	55	16	M16
PF5X 150-60	AV002280	150	60	16	M16
PF5X 150-75	AV002281	150	75	16	M16
PF5X 150-100	AV002282	150	100	20	M20

Waisted Bobbins - Type: **ATX Hardness 55 SHORE** / *Antivibrante Sgolato* - Tipo: **ATX Durezza 55 SHORE**

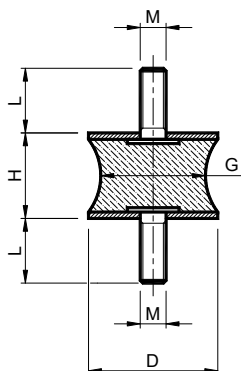

Antivibration mounts made by rubber and steel parts
MATERIALS metal components are in stainless steel
 NR/SBR rubber compound
HARDNESS 55 SHORE +/-5%
USE male-male

Antivibranti gomma-metallo
MATERIALI parti metalliche sono inox
 Parti in gomma mescola NR/SBR
DUREZZA 55 SHORE +/-5%
IMPIEGO maschio-maschio

Type Tipo	Cod. N°	D	H	G	L	M
ATX 10-10	AV002350	10	10	10	8	M4
ATX 20-15	AV002354	20	15	18	14	M6
ATX 20-19	AV002355	20	19	15	14	M6
ATX 20-30	AV002356	20	30	12	12	M6
ATX 20-40	AV002357	20	40	12	15	M6
ATX 25-20	AV002362	25	20	15	18	M6
ATX 30-20	AV002367	30	20	20	25	M8
ATX 30-25	AV002368	30	25	15	23	M8
ATX 40-28	AV002374	40	28	28	35	M10

Type Tipo	Cod. N°	D	H	G	L	M
ATX 40-30	AV002375	40	30	20	25	M8
ATX 40-48	AV002376	40	48	23	20	M8
ATX 46-25	AV002380	46	25	20	40	M10
ATX 50-30	AV002384	50	30	33	41	M10
ATX 60-60	AV002388	60	60	28	49	M10
ATX 75-40	AV002393	75	40	37	54	M12
ATX 100-55	AV002398	100	55	43	80	M16
ATX 100-75	AV002399	100	75	41	95	M16

Waisted Bobbins - Type: **BTX Hardness 55 SHORE** / *Antivibrante Sgolato* - Tipo: **BTX Durezza 55 SHORE**

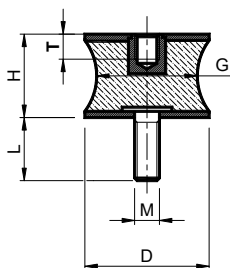



Antivibration mounts made by rubber and steel parts
MATERIALS metal components are in stainless steel
 NR/SBR rubber compound
HARDNESS 55 SHORE +/-5%
USE female-male

Antivibranti gomma-metallo
MATERIALI parti metalliche sono inox
 Parti in gomma mescola NR/SBR
DUREZZA 55 SHORE +/-5%
IMPIEGO femmina-maschio

Type Tipo	Cod. N°	D	H	G	L	T	M
BTX 10-10	AV002428	10	10	10	4	8	M4
BTX 15-15	AV002431	15	15	12	5	12	M6
BTX 20-15	AV002435	20	15	18	6	14	M6
BTX 20-19	AV002436	20	19	10	6	14	M6
BTX 25-20	AV002439	25	20	18	6	18	M6
BTX 30-20	AV002442	30	20	20	8	25	M8
BTX 40-30-M8	AV002445	40	30	23	8	25	M8
BTX 40-30-M10	AV002446	40	30	20	10	25	M10
BTX 55-45	AV002449	55	45	28	10	46	M10
BTX 60-60	AV002452	60	60	28	10	49	M10

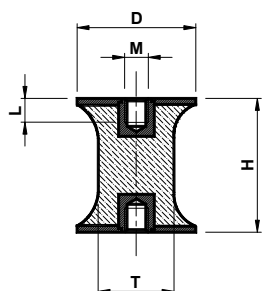
Waisted Bobbins - Type: CTX Hardness 55 SHORE / Antivibrante Sgolato - Tipo: CTX Durezza 55 SHORE





 Antivibration mounts made by rubber and steel parts
MATERIALS metal components are in stainless steel
 NR/SBR rubber compound
HARDNESS 55 SHORE +/-5%
USE female-female

 Antivibranti gomma-metallo
MATERIALI parti metalliche sono inox
 Parti in gomma mescola NR/SBR
DUREZZA 55 SHORE +/-5%
IMPIEGO femmina-femmina

Type Tipo	Cod. N°	D	H	L	T	M
CTX 10-10	AV002487	10	10	4	8	M4
CTX 20-30	AV002490	20	30	6	14	M6
CTX 30-20	AV002493	30	20	8	25	M8
CTX 40-30	AV002496	40	30	8	33	M8
CTX 40-48	AV002497	40	48	8	20	M8
CTX 50-30	AV002500	50	30	10	41	M10
CTX 60-60	AV002503	60	60	10	49	M10
CTX 70-53	AV002506	70	53	10	45	M10
CTX 75-40	AV002509	75	40	12	54	M12
CTX 100-55	AV002512	100	55	18	80	M16

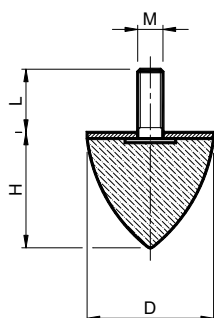
Conical Bobbins - Type: CKX Hardness 55 SHORE / Antivibrante Conico - Tipo: CKX Durezza 55 SHORE



 Antivibration mounts made by rubber and steel parts
MATERIALS metal components are in stainless steel
 NR/SBR rubber compound
HARDNESS 55 SHORE +/-5%
USE male-rubber foot

 Antivibranti gomma-metallo
MATERIALI parti metalliche sono inox
 Parti in gomma mescola NR/SBR
DUREZZA 55 SHORE +/-5%
IMPIEGO maschio-piede antivibrante

Type Tipo	Cod. N°	D	H	G	M
CKPX 10-10	AV002622	10	10	12	M5
CKPX 15-15	AV002626	15	15	10	M5
CKPX 20-15	AV002631	20	15	18	M6
CKPX 20-24	AV002632	20	24	18	M6
CKPX 25-15	AV002637	25	15	18	M6
CKPX 25-20	AV002638	25	20	10	M6
CKPX 30-30	AV002643	30	30	20	M8
CKPX 30-36	AV002644	30	36	20	M8
CKPX 35-40	AV002649	35	40	20	M8

Type Tipo	Cod. N°	D	H	G	M
CKPX 50-50	AV002654	50	50	36	M8
CKPX 50-58	AV002655	50	58	28	M10
CKPX 50-61	AV002656	50	61	26	M8
CKPX 50-67	AV002657	50	67	36	M8
CKPX 70-60	AV002662	70	60	35	M12
CKPX 75-89	AV002667	75	89	37	M12
CKPX 95-80	AV002672	95	80	42	M16
CKPX 115-136	AV002677	115	136	43	M16